

4N25 4N27
4N26 4N28

PACKAGE DIMENSIONS

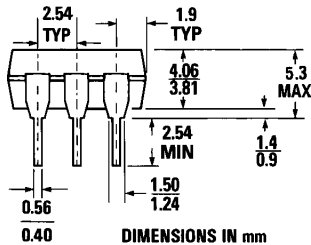
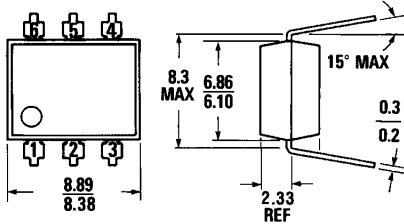

DIMENSIONS IN mm
PACKAGE CODE K

ST1603A

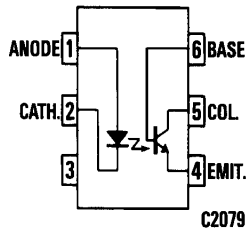

Equivalent Circuit

DESCRIPTION

The 4N25, 4N26, 4N27, and 4N28 series of optocouplers have an NPN silicon planar phototransistor optically coupled to a gallium arsenide diode.

FEATURES & APPLICATIONS

- AC line/digital logic isolator
- Digital logic/digital logic isolator
- Telephone/telegraph line receiver
- Twisted pair line receiver
- High frequency power supply feedback control
- Relay contact monitor
- Power supply monitor
- Small package size and low cost
- Excellent frequency response
- UL recognized—File E90700

ABSOLUTE MAXIMUM RATINGS

TOTAL PACKAGE

- *Storage temperature -55°C to 150°C
- *Operating temperature at junction -55°C to 100°C
- *Lead temperature (soldering, 10 sec) 260°C
- *Total package power dissipation at 25°C ambient (LED plus detector) 250 mW
- *Derate linearly from 25°C 3.3 mW/°C

INPUT DIODE

- *Forward DC current continuous 80 mA
- *Reverse voltage 3.0 V
- *Peak forward current
(300 μ s, 2% duty cycle) 3.0 A
- *Power dissipation at 25°C ambient 150 mW
- *Derate linearly from 25°C 2.0 mW/°C

OUTPUT TRANSISTOR

- *Collector emitter voltage (BV_{CE0}) 30 V
- *Collector base voltage (BV_{CBO}) 70 V
- *Emitter collector voltage (BV_{ECO}) 7 V
- *Power dissipation at 25°C ambient 150 mW
- *Derate linearly from 25°C 2.0 mW/°C

*Indicates JEDEC Registered Data.

ELECTRO-OPTICAL CHARACTERISTICS (25°C Free Air Temperature Unless Otherwise Specified)

INDIVIDUAL COMPONENT CHARACTERISTICS

CHARACTERISTICS	SYMBOL	MIN.	TYP.	GUAR. MAX.	UNITS	TEST CONDITIONS
INPUT DIODE						
*Forward voltage	V_f		1.20	1.50	V	$I_f = 10 \text{ mA}$
Capacitance	C		150		pF	$V_f = 0 \text{ V}, f = 1 \text{ MHz}$
*Reverse leakage current			.05	100	μA	$V_R = 3.0 \text{ V}, R_L = 1.0 \text{ M}\Omega$
DETECTOR						
DC forward current gain	h_{FE}		250			$V_{CE} = 5 \text{ V}, I_C = 500 \mu\text{A}$
*Collector to emitter breakdown voltage	BV_{CEO}	30	65		V	$I_C = 1.0 \text{ mA}, I_B = 0$
*Collector to base breakdown voltage	BV_{CBO}	70	165		V	$I_C = 100 \mu\text{A}, I_E = 0$
*Emitter to collector breakdown voltage	BV_{ECO}	7	14		V	$I_E = 100 \mu\text{A}, I_B = 0$
*Collector to emitter leakage current (4N25, 4N26, 4N27)	I_{CEO}		3.5	50	nA	$V_{CE} = 10 \text{ V}$ Base Open
*Collector to emitter leakage current (4N28)				100	nA	
*Collector to base leakage current	I_{CBO}		0.1	20	nA	$V_{CB} = 10 \text{ V}$ Emitter Open

TRANSFER CHARACTERISTICS

DC CHARACTERISTICS	SYMBOL	MIN.	TYP.	GUAR. MAX.	UNITS	TEST CONDITIONS
*Collector output current (a) (4N25, 4N26) (4N27, 4N28)	I_C	2.0 1.0	5.0 3.0	— —	mA	$V_{CE} = 10 \text{ V}, I_f = 10 \text{ mA}, I_B = 0$
*Collector-emitter saturation	$V_{CE(SAT)}$		0.2	0.5	V	$I_C = 2.0 \text{ mA}, I_f = 50 \text{ mA}$

TRANSFER CHARACTERISTICS

AC CHARACTERISTICS	SYMBOL	TYP.	UNITS	TEST CONDITIONS
Non-saturated Collector Delay time	t_d	0.5	μS	$R_L = 100 \Omega, I_C = 2 \text{ mA}, V_{CC} = 10 \text{ V}$ (Fig. 10 and 11)
Rise time	t_r	2.5	μS	
Fall time	t_f	2.6	μS	
Non-saturated Collector Delay time	t_d	2.0	μS	$R_L = 1\text{k}\Omega, I_C = 2 \text{ mA}, V_{CC} = 10 \text{ V}$ (Fig. 10 and 11)
Rise time	t_r	15	μS	
Fall time	t_f	15	μS	

*Indicates JEDEC Registered Data.

(a) Pulse Test: Pulse Width = 300 μs , Duty Cycle $\leq 2.0\%$

(b) For this test LED pins 1 and 2 are common and Phototransistor pins 4, 5 and 6 are common.

(c) If adjusted to yield $I_C = 2 \text{ mA}$ and $t_c = 0.7 \text{ mA RMS}$; Bandwidth referenced to 10 kHz.

ELECTRO-OPTICAL CHARACTERISTICS (25°C Free Air Temperature Unless Otherwise Specified) (Cont'd)

TRANSFER CHARACTERISTICS (Cont'd)

AC CHARACTERISTICS	SYMBOL	MIN.	TYP.	GUAR. MAX.	UNITS	TEST CONDITIONS
Saturated						
t_{on} (from 5 V to 0.8 V)	t_{on} (SAT)		5		μs	$R_L=2k\Omega, I_F=15\text{ mA}, V_{CC}=5\text{ V}$
t_{off} (from SAT to 2.0 V)	t_{off} (SAT)		25		μs	$R_B=Open$ (Fig. 10)
Saturated						
t_{on} (from 5 V to 0.8 V)	t_{on} (SAT)		5		μs	$R_L=2k\Omega, I_F=20\text{ mA}, V_{CC}=5\text{ V}$
t_{off} (from SAT to 2.0 V)	t_{off} (SAT)		18		μs	$R_B=100k\Omega$ (Fig. 10)
Non-saturated						
Base—Collector photo diode						
Rise time	t_r		175		ns	$R_L=1k\Omega, V_{CB}=10\text{ V}$
Fall time	t_f		175		ns	
Isolation voltage (b) (4N25, 4N26, 4N27, 4N28) *(4N26, 4N27) *(4N28)	V_{iso}	5300 1500 500	— — —	— — —	V V V	$I_{i0} \leq 1\ \mu A$ RMS, $t=1\text{ minute}$ Peak Peak
Isolation resistance (b)			10^{11}		Ω	$V=500\text{ VDC}$
Isolation capacitance (b)			1.3		pF	$V=0, f=1.0\text{ MHz}$
Bandwidth (c) (also see note 2)	B_w		300		kHz	$I_C=2.0\text{ mA}, R_L=100\ \Omega$ (Fig. 12)

*Indicates JEDEC Registered Data.

(a) Pulse Test: Pulse Width=300 μs , Duty Cycle $\leq 2.0\%$

(b) For this test LED pins 1 and 2 are common and Phototransistor pins 4, 5 and 6 are common.

(c) If adjusted to yield $I_C=2\text{ mA}$ and $i_C=0.7\text{ mA RMS}$; Bandwidth referenced to 10 kHz.

TYPICAL ELECTRO-OPTICAL CHARACTERISTIC CURVES (25°C Free Air Temperature Unless Otherwise Specified)

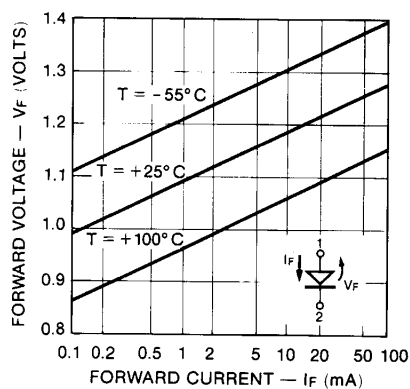

Fig. 1. Forward Voltage vs. Current

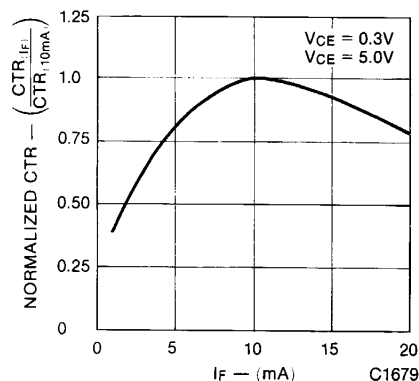

Fig. 2. Normalized CTR vs. Forward Current

TYPICAL ELECTRO-OPTICAL CHARACTERISTIC CURVES
(25°C Free Air Temperature Unless Otherwise Specified) (Cont'd)

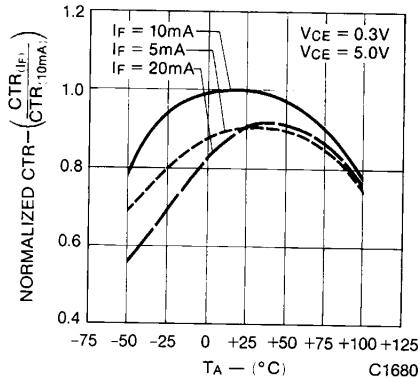

Fig. 3. Normalized CTR vs. Temperature

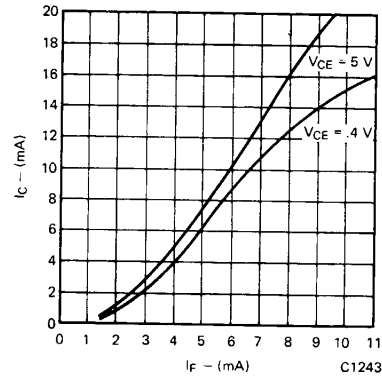

Fig. 4. Collector Current vs. Forward Current

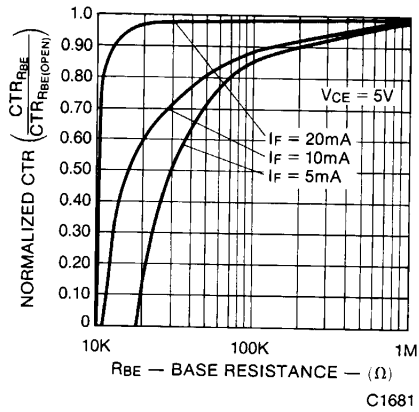

Fig. 5. CTR vs. R_{BE} (Unsaturated)

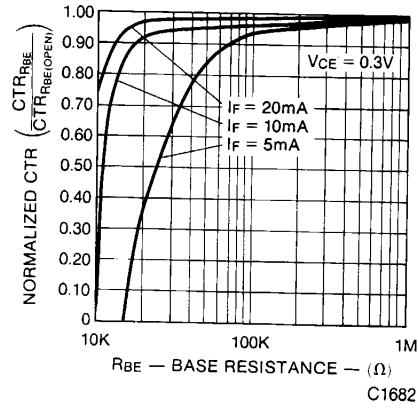

Fig. 6. CTR vs. R_{BE} (Saturated)

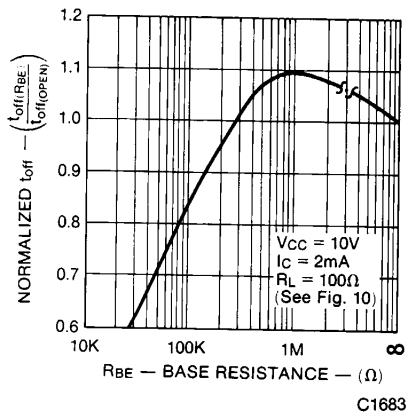

Fig. 7. Normalized T_{off} vs. R_{BE}

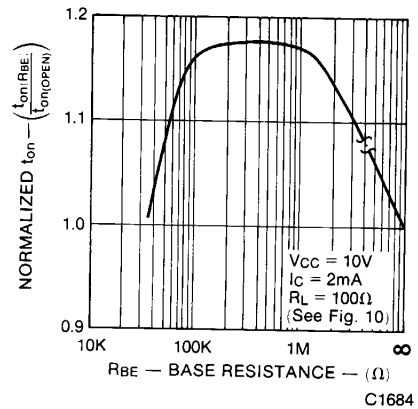

Fig. 8. Normalized T_{on} vs. R_{BE}

TYPICAL ELECTRO-OPTICAL CHARACTERISTIC CURVES
(25°C Free Air Temperature Unless Otherwise Specified) (Cont'd)

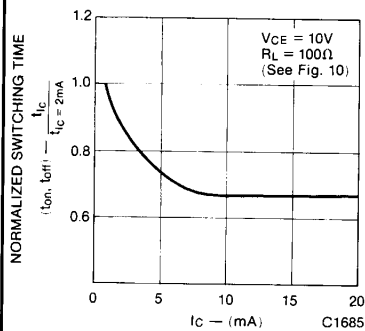

Fig. 9. Switching Time vs. IC

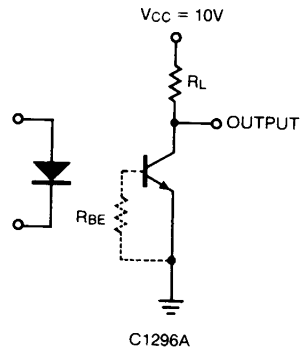

Fig. 10. Switching Time Test Circuit

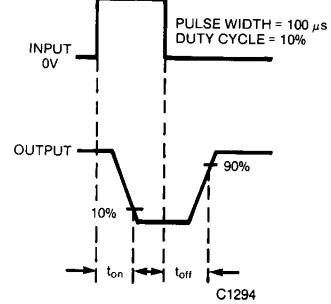

Fig. 11. Switching Time Waveforms

OPERATING SCHEMATICS

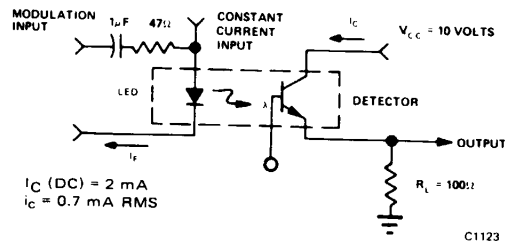

Fig. 12. Modulation Circuit Used to Obtain Output vs. Frequency Plot

NOTES

1. The current transfer ratio (I_C/I_F) is the ratio of the detector collector current to the LED input current with V_{CE} at 10 volts.
2. The frequency at which i_c is 3dB down from the 10 kHz value.
3. Rise time (t_r) is the time required for the collector current to increase from 10% of its final value to 90%.
Fall time (t_f) is the time required for the collector current to decrease from 90% of its initial value to 10%.

This datasheet has been download from:

www.datasheetcatalog.com

Datasheets for electronics components.