

PREPARED BY: <i>M. Mitani</i> DATE: <i>August 24, 1994</i>	<b>SHARP</b>  ELECTRONIC COMPONENTS GROUP SHARP CORPORATION  <b>SPECIFICATION</b>	SPEC No. ED-92013A
APPROVED BY: <i>J. Yoshikawa</i> DATE: <i>Aug, 24, 1994</i>		ISSUE August 24, 1994
		PAGE 13 Pages
		REPRESENTATIVE DIVISION  OPTO-ELECTRONIC DEVICES DIV.

DEVICE SPECIFICATION FOR  
**PHOTOCOUPLER**

MODEL No.  
**PC817**  
(4-channel type)

Business dealing name

PC847	PC847Y
PC847AB	PC847Y5
PC847BC	PC847Y6
PC847CD	PC847Y7
PC847AC	PC847Y8
PC847BD	PC847Y9
PC847AD	PC847Y0

1. This specification sheets include the contents under the copyright of Sharp Corporation ("Sharp"). Please keep them with reasonable care as important information. Please don't reproduce or cause anyone reproduce them without Sharp's consent.
2. Please obey the instructions mentioned below for actual use of this device.  
Contact a SHARP representative of sales office in advance when you intend to use SHARP devices for any applications other than those applications for general electronic equipment recommend by SHARP at (1).
  - (1) This device is designed for general electronic equipment.  
Main uses of this device are as follows:
 

<ul style="list-style-type: none"> <li>• OA equipment</li> <li>• AV equipment</li> <li>• Home appliance</li> <li>• Telecommunication equipment (Terminal)</li> <li>• Measuring equipment</li> <li>• Tooling machine</li> <li>• Computer, etc.</li> </ul>
--
  - (2) Please take proper steps in order to maintain reliability and safety, in case this device is used for the uses mentioned below which require high reliability.
 

<ul style="list-style-type: none"> <li>• Unit concerning control and safety of a vehicle (air plane, train, automobile etc.)</li> <li>• Gas leak detection breaker</li> <li>• Traffic signal</li> <li>• Fire box and burglar alarm box</li> <li>• Other safety equipment, etc.</li> </ul>
---
  - (3) Please do not use for the uses mentioned below which require extremely high reliability.
 

<ul style="list-style-type: none"> <li>• Space equipment</li> <li>• Telecommunication equipment (Trunk)</li> <li>• Nuclear control equipment</li> <li>• Medical equipment etc.</li> </ul>
---

CUSTOMER'S APPROVAL \_\_\_\_\_

DATE \_\_\_\_\_

BY \_\_\_\_\_

DATE PRESENTED BY           *T. M*          

T. Matsumura,  
Department General Manager of  
Engineering Dept., II  
Opto-Electronic Devices Div.  
ELECOM Group  
SHARP CORPORATION

**1. Application**

This specification applies to the outline and characteristics of photocoupler Model No. PC817 (4-channel type).

**2. Outline**

Refer to the attached drawing No. CY537OK02.

**3. Ratings and characteristics**

Refer to the attached sheet, page 4, 5.

**4. Reliability**

Refer to the attached sheet, page 7.

**5. Incoming inspection**

Refer to the attached sheet, page 8.

**6. Supplement****6.1 Isolation voltage shall be measured in the following method.**

- (1) Short between anode to cathode on the primary side and between collector to emitter on the secondary side.
- (2) The dielectric withstand tester with zero-cross circuit shall be used.
- (3) The wave form of applied voltage shall be a sine wave.  
(It is recommended that the isolation voltage be measured in insulation oil.)

**6.2 Collector current (I<sub>c</sub>) Delivery rank table**

("O" mark indicates business dealing name of ordered product)

Rank at delivery	Business dealing name	Rank at delivery	* Business dealing name	I <sub>c</sub> (mA)
	PC847		PC847Y	2.5 to 30
	PC847AB		PC847Y5	4.0 to 13
	PC847BC		PC847Y6	6.5 to 20
	PC847CD		PC847Y7	10 to 30
	PC847AC		PC847Y8	4.0 to 20
	PC847BD		PC847Y9	6.5 to 30
	PC847AD		PC847Y0	4.0 to 30

Test conditions
I <sub>f</sub> =5mA
V <sub>CE</sub> =5V
T <sub>a</sub> =25°C

\* Applied to products as a option (Attach sheet 2-1 to 2-4)

6.3 This Model is approved by UL.

Approved Model No. : PC817

UL file No. : E64380

6.4 This product is not designed against irradiation.

This product is assembled with electrical input and output.

This product incorporates non-coherent light emitting diode.

## 7. Notes

### 7.1 For cleaning

(1) Solvent cleaning : Solvent temperature 45°C or less  
Immersion 3 min. or less

(2) Ultrasonic cleaning : The affect to device by ultrasonic cleaning is different by cleaning bath size, ultrasonic power output, cleaning time, PWB size or device mounting condition etc. Please test it in actual using condition and confirm that doesn't occur any defect before starting the ultrasonic cleaning.

Applicable solvent : Ethyl alcohol, Methyl alcohol  
Freon TE · TF, Diflon-solvent S3-E

Please refrain from using Chloro Fluoro Carbon type solvent to clean device as much as possible since it is internationally restricted to protect the ozonosphere. Before you use alternative solvent you are requested to confirm that it does not attack package resin.

7.2 The LED used in the Photocoupler generally decreases the light emission power by operation. In case of long operation time, please design the circuit with considering the degradation of the light emission power of the LED. (50%/5years)

### 7.3 Precaution for Soldering Photocoupler

Refer to the attached sheet-1.

## 8. Others

Any doubt as to this specification shall be determined in good faith upon mutual consultation of the both parties.

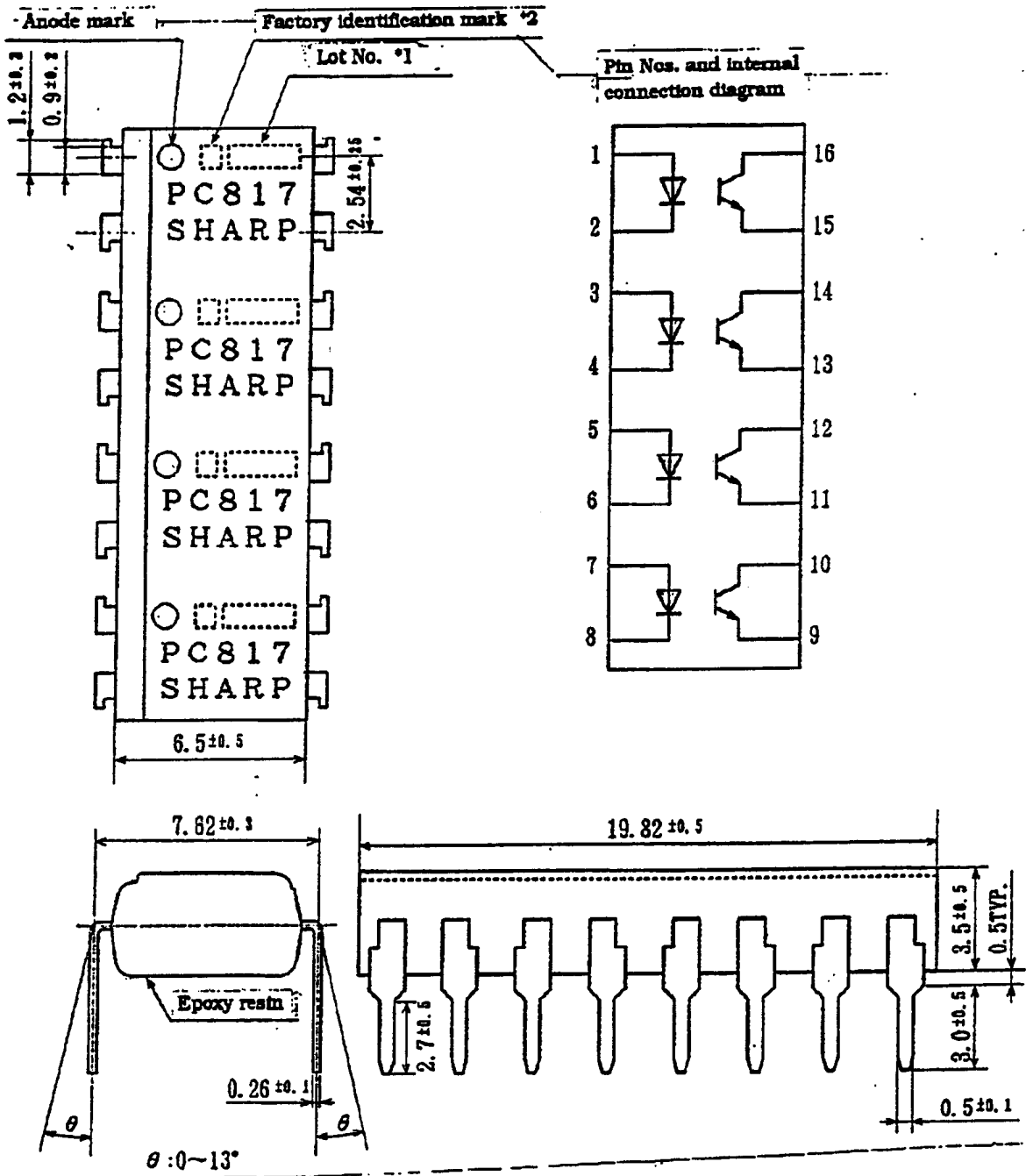

\*1) 2-digit number marked according to DIN standard.

\*2) Factory identification mark shall be or shall not be marked.

UNIT: 1/1 mm

Name	PC817 (4-channel type) Outline Dimensions (Business dealing name : PC847)
Drawing No.	CY537OK02

## 3. Ratings and characteristics

## 3.1 Absolute maximum ratings

Ta=25°C

	Parameter	Symbol	Rating	Unit
Input	*1 Forward current	$I_F$	50	mA
	*2 Peak forward current	$I_{FM}$	1	A
	Reverse voltage	$V_R$	6	V
	*1 Power dissipation	P	70	mW
Output	Collector-emitter voltage	$V_{CEO}$	35	V
	Emitter-collector voltage	$V_{ECO}$	6	V
	Collector current	$I_C$	50	mA
	*1 Collector power dissipation	$P_C$	150	mW
	*1 Total power dissipation	$P_{tot}$	200	mW
	*3 Isolation voltage	$V_{iso}$	5	kV <sub>rms</sub>
	Operating temperature	$T_{opr}$	-30 to +100	°C
	Storage temperature	$T_{stg}$	-55 to +125	°C
	*4 Soldering temperature	$T_{sol}$	260	°C

\*1 The derating factors of absolute maximum ratings due to ambient temperature are shown in Fig. 1 to 4.

\*2 Pulse width  $\leq 100 \mu s$ , Duty ratio : 0.001 (Refer to Fig. 5)

\*3 AC for 1 min., 40 to 60%RH

\*4 For 10 s

## 3.2 Electro-optical characteristics

Ta=25°C

	Parameter	Symbol	Condition	MIN.	TYP.	MAX.	Unit
Input	Forward voltage	$V_F$	$I_F=20\text{mA}$	-	1.2	1.4	V
	Peak forward voltage	$V_{FM}$	$I_{FM}=0.5\text{A}$	-	-	3.0	V
	Reverse current	$I_R$	$V_R=4\text{V}$	-	-	10	$\mu\text{A}$
	Terminal capacitance	$C_t$	$V=0, f=1\text{kHz}$	-	30	250	pF
Output	Dark current	$I_{CEO}$	$V_{CE}=20\text{V}, I_F=0$	-	-	100	nA
	Collector-emitter breakdown voltage	$BV_{CEO}$	$I_C=0.1\text{mA}$ $I_F=0$	35	-	-	V
	Emitter-collector breakdown voltage	$BV_{ECO}$	$I_E=10\mu\text{A}, I_F=0$	6	-	-	V
Transfer characteristics	Collector current	$I_C$	$I_F=5\text{mA}, V_{CE}=5\text{V}$	2.5	-	30	mA
	Collector-emitter saturation voltage	$V_{CE(sat)}$	$I_F=20\text{mA}$ $I_C=1\text{mA}$	-	0.1	0.2	V
	Isolation resistance	$R_{ISO}$	DC=500V 40 to 60%RH	$5 \times 10^{10}$	$10^{11}$	-	$\Omega$
	Floating capacitance	$C_f$	$V=0, f=1\text{MHz}$	-	0.6	1.0	pF
	Cut-off frequency	$f_c$	$V_{CE}=5\text{V}, I_C=2\text{mA}$ $R_L=100\Omega, -3\text{dB}$	-	80	-	kHz
	Rise time	$t_r$	$V_{CE}=2\text{V}$ $I_C=2\text{mA}$	-	4	18	$\mu\text{s}$
	Fall time	$t_f$	$R_L=100\Omega$	-	3	18	$\mu\text{s}$

(Fig. 1) Forward current vs. ambient temperature

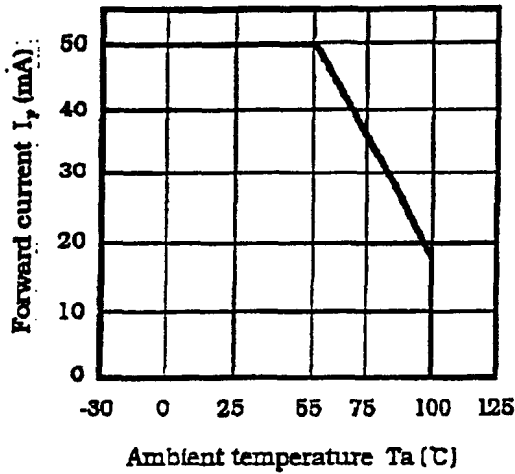

(Fig. 2) Diode power dissipation vs. ambient temperature

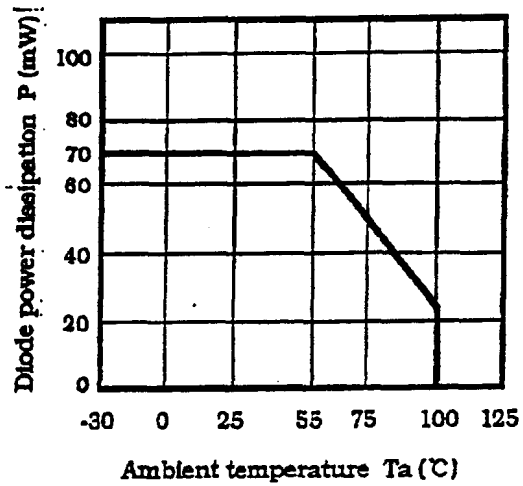

(Fig. 3) Collector power dissipation vs. ambient temperature

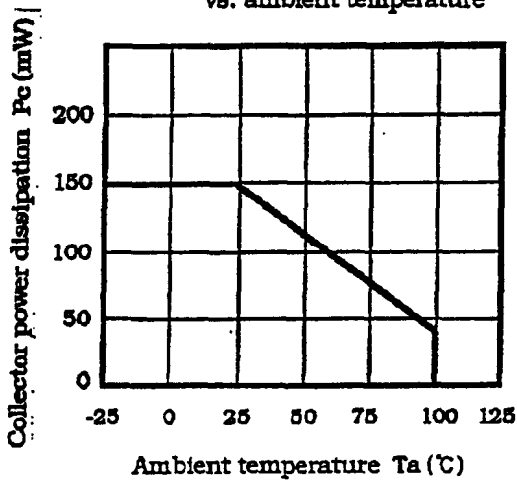

(Fig. 4) Total power dissipation vs. ambient temperature

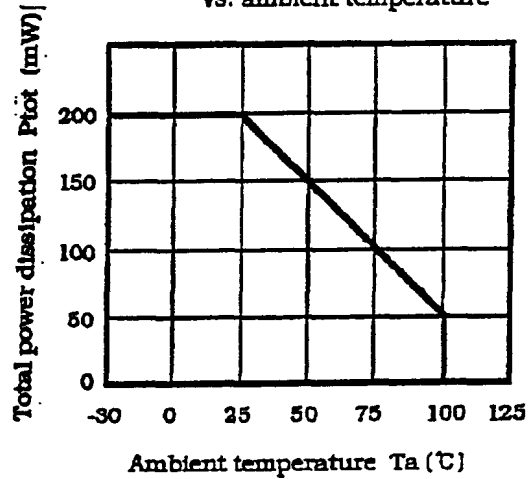

(Fig. 5) Peak forward current vs. duty ratio

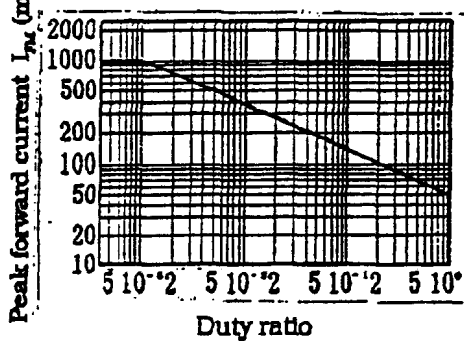

Pulse width  $\leq 100 \mu s$   
 $T_a = 25^\circ C$

4. Reliability

The reliability of products shall be satisfied with items listed below.

Confidence level : 90%  
LTPD : 10%/20%

Test Items	Test Conditions *1	Failure Judgement Criteria	Samples (n)
			Defective(C)
Solderability *2	230°C, 5 s	—	n=11, C=0
Soldering heat	260°C, 10 s	$V_p > U \times 1.2$ $I_R > U \times 2$ $I_{C20} > U \times 2$ $I_C < L \times 0.7$ $V_{CD(test)} > U \times 1.2$  U : Upper specification limit  L : Lower specification limit	n=11, C=0
Terminal strength (Tension)	Weight : 5N 5 s/each terminal		n=11, C=0
Terminal strength (Bending) *3	Weight : 2.5N 2 times/each terminal		n=11, C=0
Mechanical shock	15000m/s <sup>2</sup> , 0.5ms 3 times/ ±X, ±Y, ±Z direction		n=11, C=0
Variable frequency vibration	100 to 2000 to 100Hz/4min. 200m/s <sup>2</sup> 4 times/ X, Y, Z direction		n=11, C=0
Temperature cycling	1 cycle -55°C to +125°C (30min.) (30min.) 20 cycles test		n=22, C=0
High temp. and high humidity storage	+60°C, 90%RH, 1000h		n=22, C=0
High temp. storage	+125°C, 1000h		n=22, C=0
Low temp. storage	-55°C, 1000h		n=22, C=0
Operation life	$I_p=50mA$ , $P_{tot}=200mW$ $T_a=25°C$ , 1000h		n=22, C=0

\*1 Test method, conforms to JIS C 7021.

\*2 Solder shall adhere at the area of 95% or more of immersed portion of lead and pin hole or other holes shall not be concentrated on one portion.

\*3 Terminal bending direction is shown below.

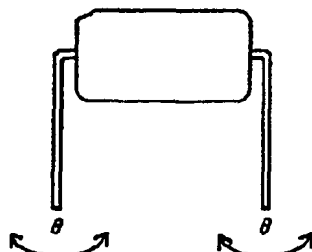



**5. Incoming inspection****5.1 Inspection items****(1) Electrical characteristics** $V_F, I_R, I_{CEO}, V_{CE(sat)}, I_C, R_{DS}, V_{ISO}$ **(2) Appearance****5.2 Sampling method and Inspection level**

A single sampling plan, normal inspection level II based on MIL-STD-105D is applied. The AQL according to the inspection items are shown below.

Defect	Inspection item	Inspection level	AQL (%)
Major defect	Electrical characteristics Unreadable marking	Normal inspection II	0.1
Minor defect	Appearance defect except the above mentioned.	Normal inspection II	0.4

Precautions for Soldering Photocouplers

1. In case of soldering to lead  
260°C 10 s or less

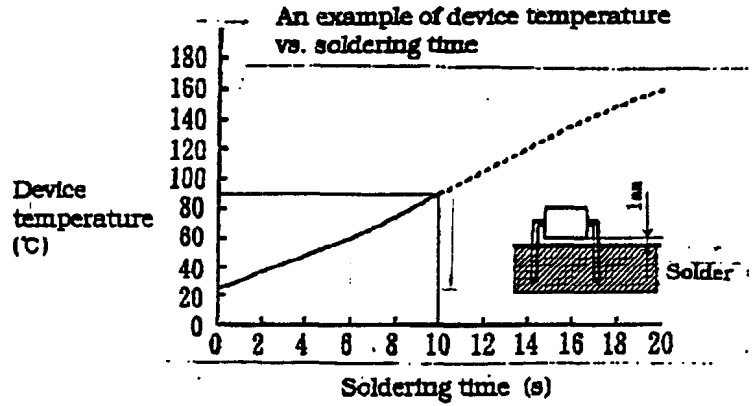

2. If solder reflow :

It is recommended that only one soldering be done at the temperature and the time within the temperature profile as shown in the figure.

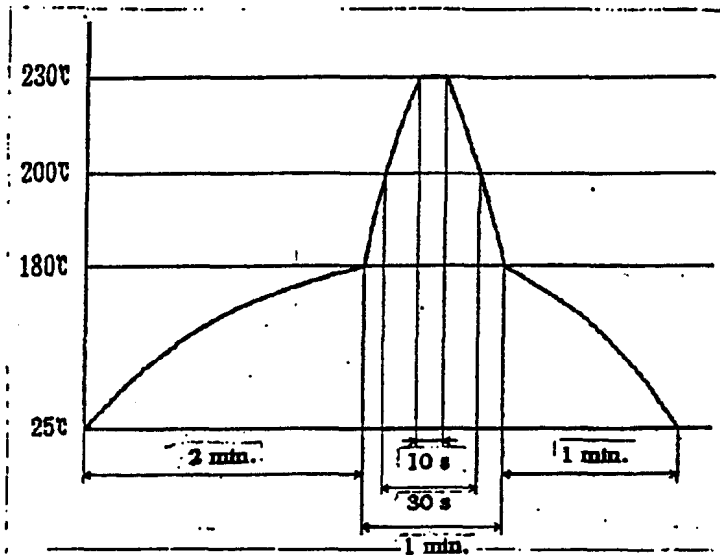

3. Other precautions

An infrared lamp used to heat up for soldering may cause a localized temperature rise in the resin. So keep the package temperature within that specified in Item 2. Also avoid immersing the resin part in the solder.

1. This specification shall be applied to photocoupler, Model No. PC817 (4-channel type) as a option.

2. Applicable Models (Business dealing name)

PC847Y, PC847Y5, PC847Y6, PC847Y7, PC847Y8, PC847Y9, PC847Y0

3. The relevant models are the models Approved by TÜV Rheinland Japan according to DIN VDE0884/08.87.

Approved Model No. : PC817

TÜV approved No. : 9151333  
(According to the specification DIN VDE0884/08.87)

- Operating isolation voltage  $U_{ICRM}$  : 710V (Peak)
- Transient voltage  $U_{TR}$  : 6000V (Peak)
- Pollution : 2 (According to VDE0110/01.89)
- Clearances distance (Between input and output) : 6mm (MIN.)
- Creepage distance (Between input and output) : 6mm (MIN.)
- Isolation thickness between input and output : 0.15mm (MIN.)
- Tracking-proof : CTI 225 (Material group IIIa : VDE0110/01.89)
- Safety limit values  
Current (I<sub>si</sub>) : 120mA (Diode side)  
Power (P<sub>si</sub>) : 260mW (Phototransistor side)  
Temperature (T<sub>si</sub>) : 150°C

In order to keep safety electric isolation of photocoupler, please set the protective circuit to keep within safety limit values when the actual application equipment troubled.

- Indication of TÜV approval prints "△ 0884" on sleeve package.

4. Outline

Refer to the attached drawing No. CY5173K02.

## 5. Isolation specification according to VDE 0884

Parameter	Symbol	Conditions	Rating	Unit	Remark	
Class of environmental test	-	DIN IEC68	30/100/21	-		
Pollution	-	DIN VDE0110	2	-		
Maximum operating isolation voltage	$U_{ORM}$	-	710	$V_{PEAK}$		
Partial discharge test voltage (Between input and output)					Refer to the Diagram 1, 2	
	Diagram 1	$U_{pr}$	$t_p=60\text{ s}, q_c<5\text{pC}$	852		$V_{PEAK}$
	Diagram 2		$t_p=1\text{ s}, q_c<5\text{pC}$	1136		$V_{PEAK}$
Maximum over-voltage	$U_{INITIAL}$	$t_{NM}=10\text{ s}$	6000	$V_{PEAK}$		
Safety maximum ratings						
1) Case temperature	$T_{sl}$	$I_p=0, P_c=0$	150	$^{\circ}\text{C}$	Refer to the Fig. 6, 7	
2) Input current	$I_{sl}$	$P_c=0$	120	mA		
3) Electric power (Output or Total power dissipation)	$P_{sl}$	-	260	mW		
Isolation resistance (Test voltage between input and output ; DC500V)	$R_{SO}$	$T_a=T_{sl}$	MIN. $10^9$	$\Omega$		
		$T_a=T_{opr}(\text{MAX.})$	MIN. $10^{11}$			
		$T_a=25^{\circ}\text{C}$	MIN. $10^{12}$			

## 6. Precautions in performing isolation test

6.1 Partial discharge test methods shall be the ones according to the specifications of VDE 0884/08.87

6.2 Please don't carry out isolation test (Viso) over  $U_{INITIAL}$ . This product deteriorates isolation characteristics by partial discharge due to applying high voltage (ex.  $U_{INITIAL}$ ). And there is possibility that this product occurs partial discharge in operating isolation voltage. ( $U_{ORM}$ ).

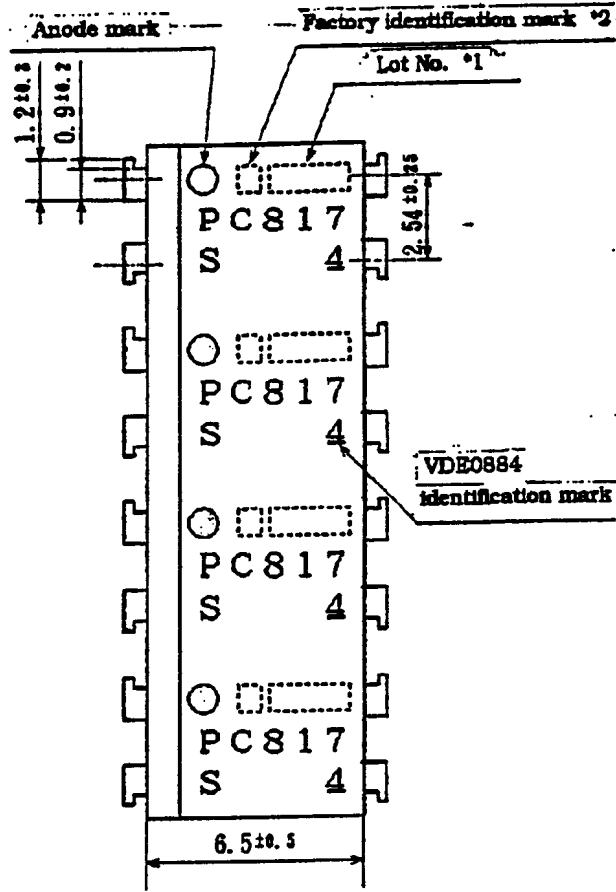

Pin Nos. and internal connection diagram

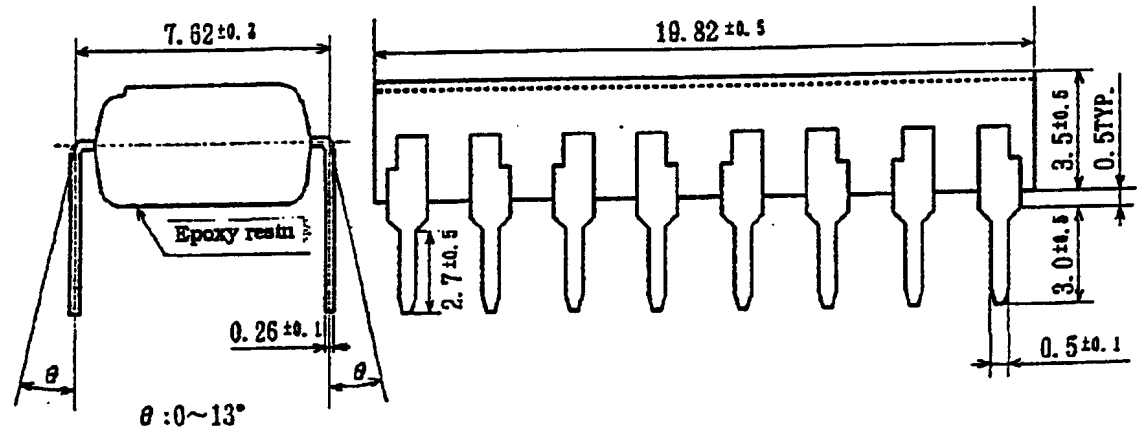
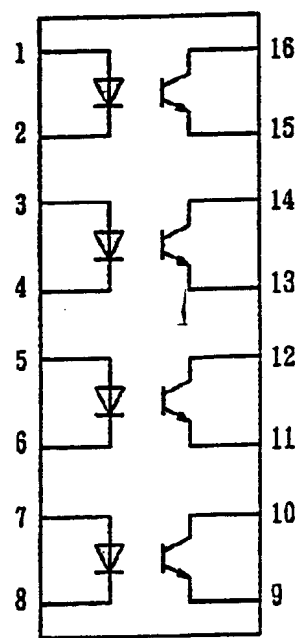

\*1) 2-digit number marked according to DIN standard.  
 \*2) Factory identification mark shall be or shall not be marked.

UNIT : 1/1 mm	
Name	PC817 (4-channel type) Outline Dimensions (Business dealing name : PC847Y)
Drawing No.	CY5173K02

Method of Diagram 1 : Breakdown test (Apply to type test and sampling test)

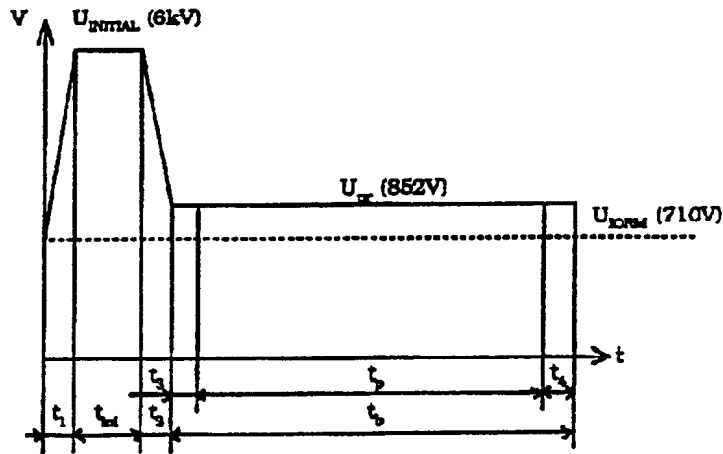

$t_1, t_2$	=1 to 10 s
$t_3, t_4$	=1 s
$t_5$ (Partial discharge measuring time)	=60 s
$t_6$	=62 s
$t_7$	=10 s

Method of Diagram 2 : Non breakdown test (Apply to all device test)

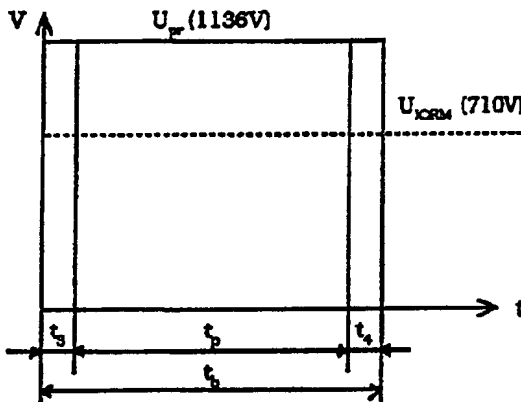

$t_5, t_6$	=0.1 s
$t_7$ (Partial discharge measuring time)	=1 s
$t_8$	=1.2 s

Fig. 6 Safety maximum power dissipation vs. ambient temperature (When failed)

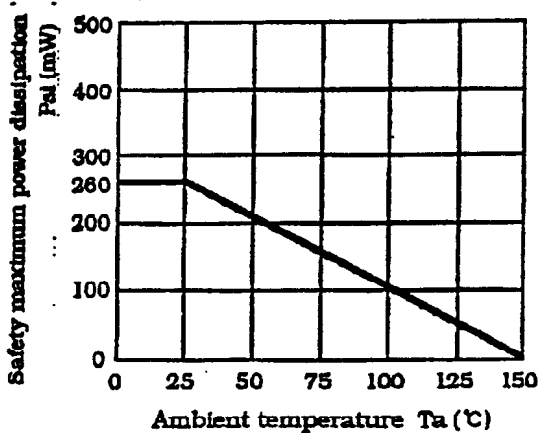
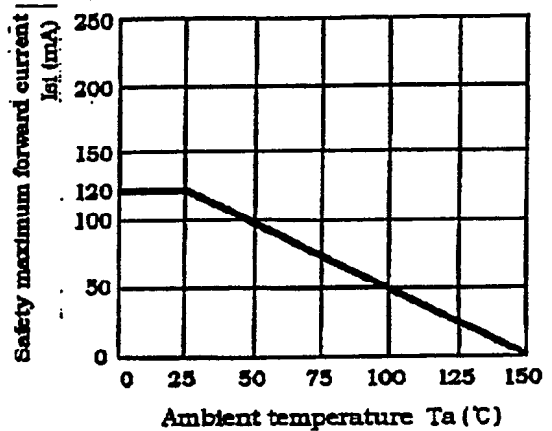

Fig. 7 Safety maximum forward current vs. ambient temperature (When failed)



This datasheet has been download from:

[www.datasheetcatalog.com](http://www.datasheetcatalog.com)

Datasheets for electronics components.